

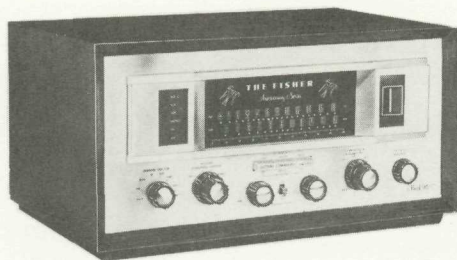

**THE FISHER 90-T**  
**SERVICE**  
**MANUAL**

MODEL 90-T



**SERIAL NUMBERS**  
**20001 — 29999 INCLUSIVE**

PRICE: \$1.00

**FISHER RADIO CORPORATION • NEW YORK**





# VOLTAGE AND RESISTANCE MEASUREMENTS

## Voltage Reference Chart

Set line voltage at 117 volts AC, 50-60 cycles. Readings are in DC volts with respect to chassis ground, unless otherwise noted. Use vacuum-tube voltmeter.

SYMBOL TUBES	CHNL SEL.	TUBE SOCKET PINS								
		1	2	3	4	5	6	7	8	9
V1	FM	85	0	1.5	7 AC	0	170	80	85	0
V2	FM	125	-1.5a	0	0	6.3 AC	140	-1.5a	0	0
V3	FM	0	P	6.3 AC	0	190	50	0	X	X
	AM	N	P	6.3 AC	0	220	60	0	X	X
V4	FM	55	N	0	6.3 AC	0	190	N	N	0
	AM	60	N	0	6.3 AC	0	220	N	N	0
V5	FM	0	P	6.3 AC	0	190	90	0	X	X
V6	FM	18b	21c	6.3 AC	0	190c	90c	21c	X	X
V7	AM	N	1	0	6.3 AC	200	85	0	X	X
V8	AM	-9	0	6.3 AC	0	225	85	N	X	X
V9	FM	2.3b	0	6.3 AC	0	N	N	18b	X	X
	AM	N	0	6.3 AC	0	N	N	N	X	X
V10	FM	N	X	0	0	6.3 AC	180	50	X	50
	AM	N	X	0	0	6.3 AC	200	50	X	50
V11	ALL	60	N	P	0	13	65	N	X	X
V12	AM	130	0	P	13	0	120	N	X	X
	OTHER	120	0	P	13	0	110	N	X	X
V13	AM	85	0	1.5	19.5	13	75	0	1.5	0
	OTHER	80	0	1.4	19.5	13	70	0	1.4	0
V14	AM	86	X	19.5	13	X	0	3	X	X
	OTHER	80	X	19.5	13	X	0	3	X	X
V15	AM	205 AC	X	245	0	6.3 AC	X	205 AC	X	X
	OTHER	205 AC	X	230	0	6.3 AC	X	205 AC	X	X

Electrolytic Capacitors	CHNL SEL.	TERMINALS (SEE PARTS LISTS)				NOTES
						
C80	AM	X	200	96	X	AC AC volts N Less than 1 volt DC, negative P Less than 1 volt DC, positive X No connection a Varies with dial setting b Varies with R47, with LOCAL pushbutton depressed c Varies with LOCAL or STANDARD pushbutton depressed
	OTHER	X	180	90	X	
C118	AM	245	230	220	218	
	OTHER	230	215	195	197	
C124	ALL	19.5	X	24	X	





All readings taken with vacuum-tube voltohmmeter with respect to chassis ground, subject to 10% normal variation unless otherwise noted. Set dial pointer at extreme low end of scale. Volume control maximum, clockwise. Tone controls flat. Loudness contour and presence controls off. Rumble filter at 20 cycles, noise filter at 20 KC. DISTANT pushbutton depressed. Refer to parts list for key to geometrical symbols used on electrolytic capacitors.

## Resistance Reference Chart

Disconnect the chassis AC power cord. Discharge all electrolytic capacitors to chassis ground through 100-ohm resistor. Disconnect all cables to associated equipment. Readings are in ohms unless otherwise noted.

SYMBOL TUBES	CHNL SEL.	TUBE SOCKET PINS								
		1	2	3	4	5	6	7	8	9
V1	FM	IMF	1M	100	L	0	40K	180K	INF	0
V2	FM	35K	1.5K	0	0	L	40K	820K	0	0
V3	FM	6	100	L	0	30K	130K	0	X	X
	AM	1.5M	100	L	0	150K	170K	0	X	X
V4	FM	220K	2.4M	0	L	0	31K	700K	76K	0
	AM	110K	2.4M	0	L	0	150K	650K	76K	0
V5	FM	L	100	L	0	40K	100K	0	X	X
V6	FM	47K	2.7K	L	0	30K	19K	2.7K	X	X
V7	AM	800K	100	0	L	150K	200K	0	X	X
V8	AM	22K	L	L	0	140K	180K	2.2M	X	X
V9	FM	500d	0	L	0	450K	100K	570K	X	X
	AM	500d	0	L	0	450K	1.5M	570K	X	X
V10	FM	220K	X	0	0	L	30K	500K	0	500K
	AM	3.3M	X	0	0	L	100K	500K	0	500K
V11	ALL	500K	330K	2.7K	0	14	500K	2.2M	2.7K	X
V12	AM	200K	450K	1.5K	14	0	200K	1M	1K	X
	OTHER	140K	450K	1.5K	14	0	140K	1M	1K	X
V13	AM	400K	X	1K	14	14	190K	0	1K	820K
	OTHER	400K	X	1K	14	14	140K	0	1K	820K
V14	AM	140K	X	14	14	X	1M	1.2K	X	X
	OTHER	85K	X	14	14	X	1M	1.2K	X	X
V15	AM	80	X	140K	0	L	X	80	X	X
	OTHER	80	X	30K	0	L	X	80	X	X

  

Electrolytic Capacitors	CHNL SEL.	TERMINALS (SEE PARTS LISTS)				NOTES
						
C80	AM	X	140K	400K	X	INF Infinite K Kilohms L Less than 1 ohm M Megohms X No connection d Varies with LOCAL pushbutton depressed
	OTHER	X	30K	300K	X	
C118	AM	140K	140K	140K	140K	
	OTHER	30K	30K	30K	30K	
C124	ALL	22	X	24	X	

# CHASSIS, TOP VIEW

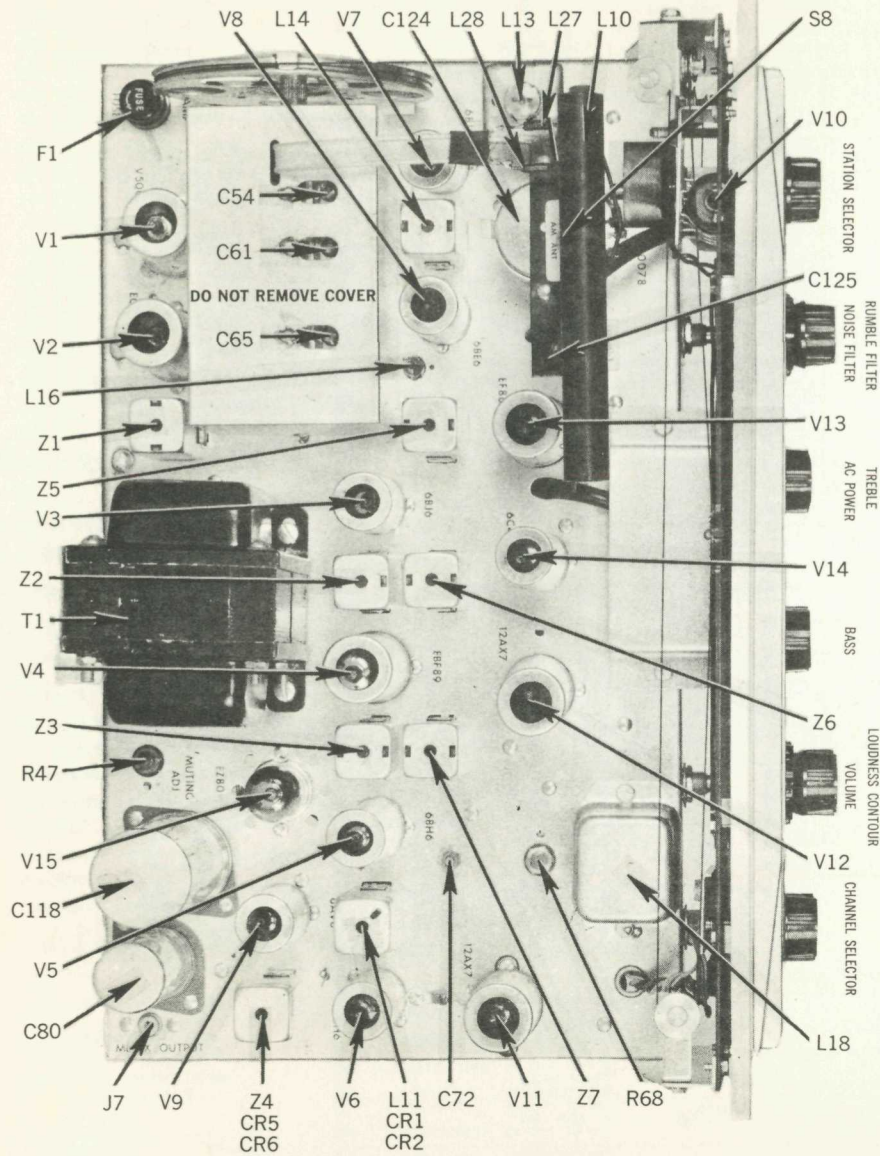

# CHASSIS, BOTTOM VIEW

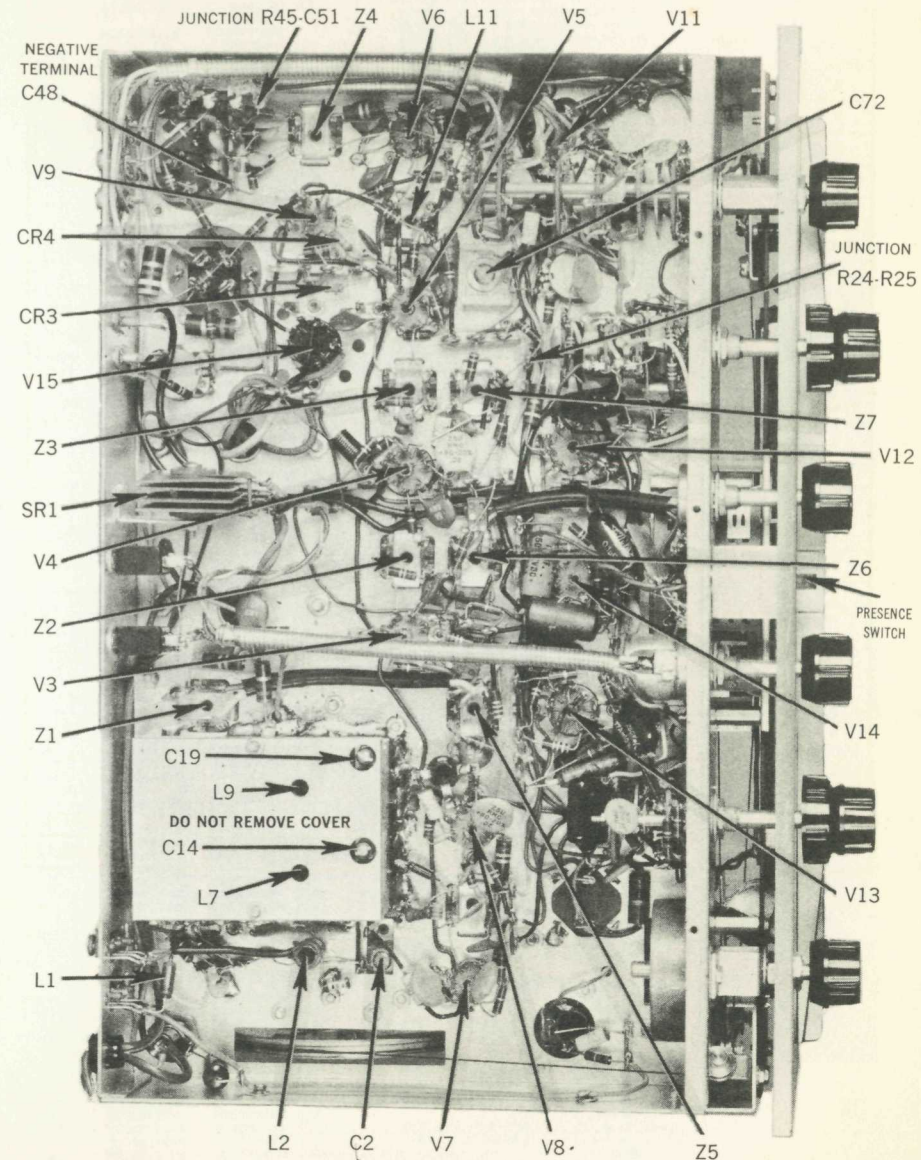



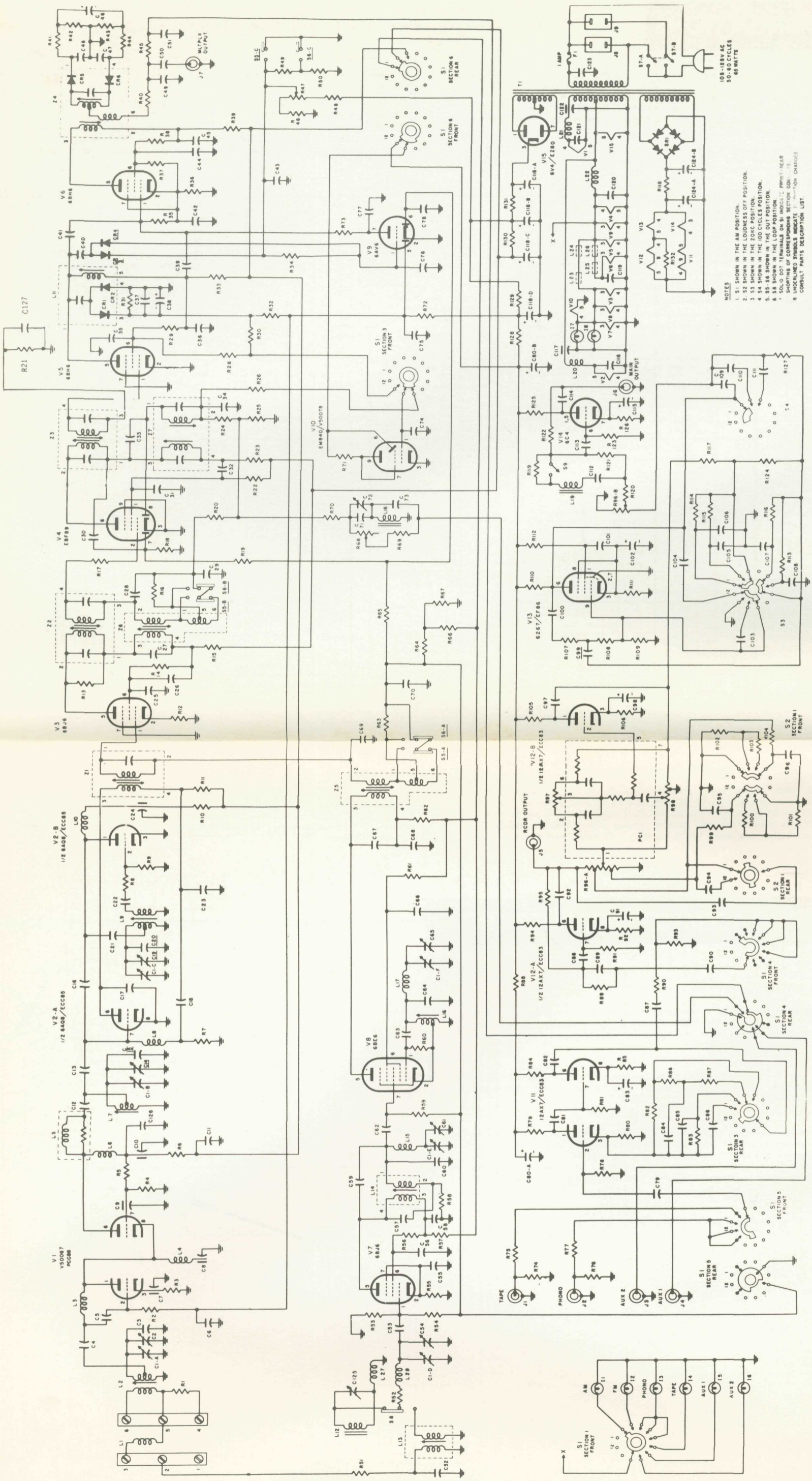

NOTES  
 1. S1 SHOWN IN THE AM POSITION.  
 2. S2 SHOWN IN THE LOUDNESS OFF POSITION.  
 3. S3 SHOWN IN THE 20K CYCLES POSITION.  
 4. S4 SHOWN IN THE 00 CYCLES POSITION.  
 5. S5-S8 SHOWN IN THE OUT POSITION.  
 6. S8 SHOWN IN THE LOOP POSITION.  
 7. SOLID DOT TERMINALS ON S1 INDICATE FRONT REAR SECTION CONNECTION CHANGES.  
 8. UNDEFINED SYMBOLS INDICATE CONSULT PARTS DESCRIPTION LIST.

# SCHEMATIC DIAGRAM

# THE FISHER 90-T

# ALIGNMENT INSTRUCTIONS

Read These Instructions With Extreme Care Before Attempting Alignment.

**CHASSIS:** Turn the Station Selector completely counterclockwise, without forcing. Dial pointer should be at zero index mark on logging scale. If not, re-set the dial pointer as described under Dial Cord Replacement. Disconnect external antennas, antenna link between terminals 1 and 2. Set tone controls to flat. Turn loudness contour control and presence switch off. Switch rumble filter to 20 cycles, and noise filter to 20 KC. When using an oscilloscope for alignment, set volume control for no overload, as shown by proper waveform shape.

**SIG. GEN:** The signal generator equipment must be able to supply the following: AM RF modulated 30% at 400 cps, FM RF modulated 30% ( $\pm 22.5$ -KC deviation) at 400 cps, accurately calibrated

10-KC audio output for adjusting 10-KC AM whistle filter, AM IF with 30-KC sweep for AM bandwidth adjustment.

**INDICATOR:** DC VTVM and SCOPE for alignment. AC VTVM for 10-KC AM whistle filter adjustment. AC VTVM and SCOPE for FM muting adjustment.

**ALIGNMENT:** Allow the chassis and test instruments to warm up for at least fifteen minutes. Adjust the line voltage for 117 volts AC, 50-60 cycles). Use fully insulated tools: a small slot-head screwdriver for all capacitors, L13 and L16; a K-tran tool for Z1, Z2, Z3, Z5, Z6, Z7, and L14; a hex tool for Z4, L2, L7 and L11.

## AM ALIGNMENT

Switch channel selector to AM.

STEPS	CHASSIS			SIGNAL GENERATOR			INDICATOR		ALIGNMENT	
	PUSH BUTTONS	LOOP SW	STATION SELECTOR	COUPLING	FREQ.	MOD.	TYPE	CONNECTION	ADJUST	INDICATION
1	AM SHARP (DISTANT)	EXT	Point of no signal and no interference	.01-uf capacitor in series with hot lead to V8, pin 7	455 KC	30% AM at 400 cps	DC VTVM	to Z7 pin 2, or SCOPE to main output	Z5, Z6, Z7 top and bottom	Maximum negative voltage
2	"	"	1400 KC	220-uuf capacitor in series with hot lead to antenna terminal 2	1400 KC	"	"	"	C54, C61, C65	"
3	"	"	600 KC	"	600 KC	"	"	"	L13, L14 L16	"
4	Repeat steps 2 and 3 at least once for proper dial calibration									
5	AM SHARP (DISTANT)	LOOP	1400 KC	Hot lead loosely coupled to loopstick	1400 KC	"	"	"	C80	"
6	AM BROAD (LOCAL)	EXT	Point of no signal and no interference	.01-uf capacitor in series with hot lead to V8, pin 7	455 KC	30-KC sweep	SCOPE	Main output	Z7 top	Adjust slightly for symmetrical curve
7	OFF (DISTANT)	-	"	Ungrounded tube shield of V2	10.7 MC	None	DC VTVM	L11, pin 3	Z1, Z2, Z3 top and bottom, L11 bottom	Maximum negative voltage
8	"	-	"	"	"	"	"	C48, neg. terminal	Z4 bottom	"
9	"	-	"	"	"	"	"	R45-C51 junction	Z4 top	Zero reading on zero-center scale
10	"	-	106 MC	Two 120-ohm carbon resistors in series with leads to antenna terminals 5 and 6	106 MC	30% FM (22.5 KC dev) at 400 cps	DC VTVM	to L11, pin 3, and SCOPE to main output	C 19	Check for sine waveform, and adjust for max negative voltage
11	"	-	90 MC	"	90 MC	"	"	"	L9	"
12	"	-	106 MC	"	106 MC	"	"	"	C2 & C14	"
13	"	-	90 MC	"	90 MC	"	"	"	L2 & L7	"
14	Repeat steps 4 through 7 at least once for proper dial calibration and maximum output									

## FM ALIGNMENT

Switch channel selector to FM.

**ADJUSTING FM MUTING LEVEL:** Connect signal generator as in step 10 of Alignment Instructions. Tune chassis to 98 MC. Set signal generator for 98 MC with 30% FM (22.5 KC deviation) at 400 cps, and 100 uv output. Connect oscilloscope to main output, and check waveform for no overload and no clipping. Connect AC VTVM to main output and observe reading with DISTANT pushbutton depressed. Depress LOCAL pushbutton, and adjust R47 for reading 2 db below reading with DISTANT pushbutton depressed.

**ADJUSTING 10-KC AM WHISTLE FILTER:** Connect an audio oscillator to the junction of R24 and R25, and set for 10 KC. The oscillator MUST be accurately calibrated, or this adjustment should not be attempted. Connect an AC VTVM to the chassis main output. Make back-and-forth adjustments of R68 and C72 until a minimum reading is obtained on the meter. Use a small slot-head screwdriver for both adjustments.

## DIAL CORD REPLACEMENT INSTRUCTIONS

1. Remove chassis from cabinet. Remove all knobs. Carefully remove the hexagonal nuts located behind the channel selector and station selector knobs. Remove the two hexagonal screws holding the brass panel assembly. These are located behind the front panel, near the upper corners. Carefully lift the brass panel away. Remove bottom cover.

2. Remove the defective cord and the dial pointer. String the new dial cord as shown in the diagram at the right. The three turns around the station selector shaft (behind the bracket) are made back-to-front in a clockwise direction.

3. Turn the station selector to its extreme counterclockwise position, without forcing. Slip the dial pointer onto the top edge of the metal front panel and position at the index mark at the low end of the logging scale. Thread the dial cord in the three clips at the back of the dial pointer, after affixing a small piece of tape to the cord at the point it passes under the center clip. Check the position of the dial pointer as at the beginning of this step, then apply household cement to secure the pointer to the dial cord.

4. Replace bottom cover. Replace the brass panel assembly, making sure to use both the hexagonal screws and the nuts removed in step 1.

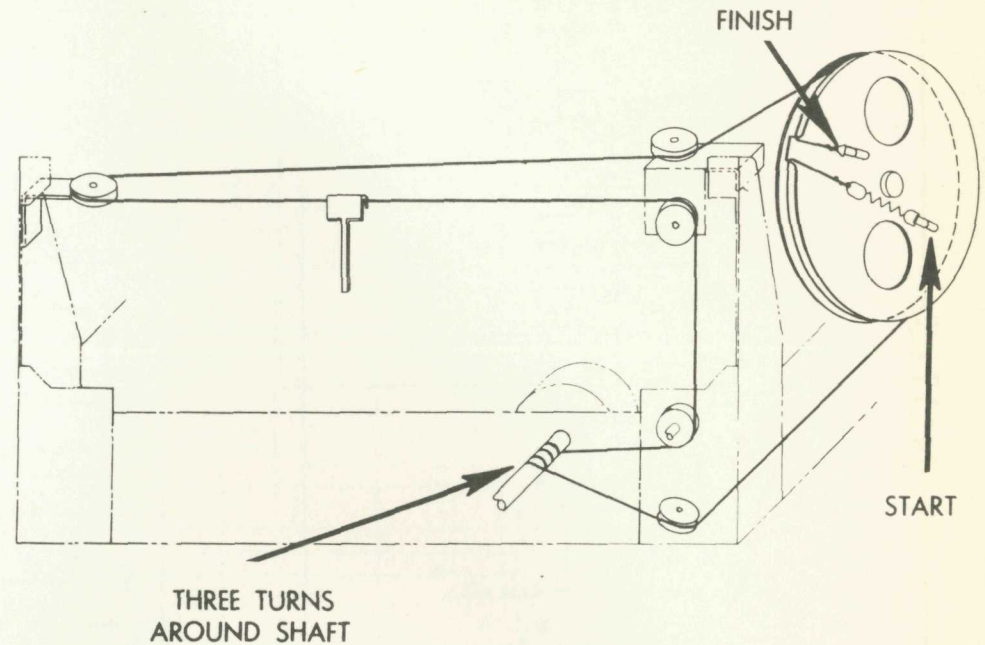

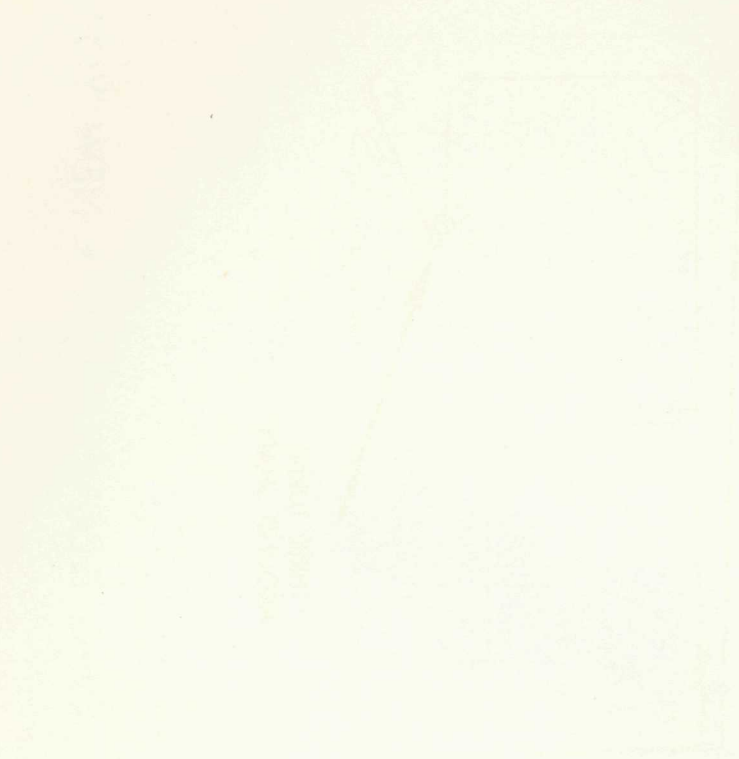

GENERAL INFORMATION





FISHER RADIO CORPORATION • LONG ISLAND CITY 1 • NEW YORK



B58F9

